

SERIES 200

Charleston Manufacturing, LLC offers a broad selection of two-inch systems, comprised of the 218, 225, 250 and 250 Econo Series. These post and panel systems are primarily designed for secondary signage applications, including directional, informational, regulatory and wayfinding. Our two-inch systems offer the designer flexibility, aesthetic quality and remarkable economy.

These systems utilize the same profiles as the 325 and 750 Series, allowing the designer a uniform appearance in secondary applications.

Post and Panel finishes include fifteen standard colors (page 12) in acrylic polyurethane. In addition, our in-house paint capabilities allow us to offer custom colors and/or color matching within standard lead times. Our finish quality is without compare.

Graphics may be furnished by Charleston Manufacturing, LLC or by the installer.

225 FULL ROUND POST

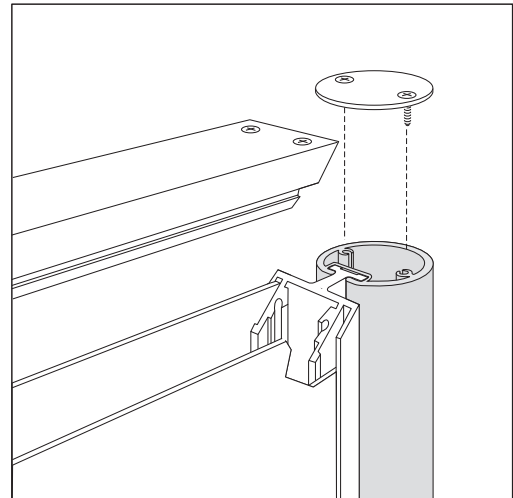
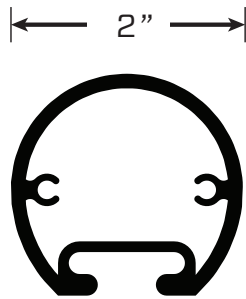

SERIES 200 CUSTOM DESIGN OPTIONS



225 STANDARD POST / CENTER MOUNT PANEL



218 SQUARE POST / FLAT PANEL



225 STANDARD POST / 250 STANDARD FRAME

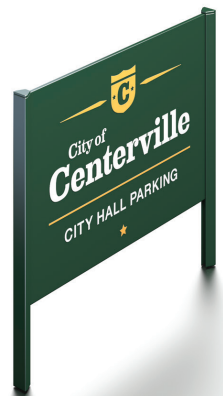

250 ECONO SIGN - 250 STANDARD POST / ALUMINUM PANEL